

# 2.7

## Valve Terminals

# General Information on Valve Terminals

Valve terminal for valves 24 V= and 24 V~.

2 - 14 stations available, equipped with varistor and red LED. Common Minus or Plus on white cable.

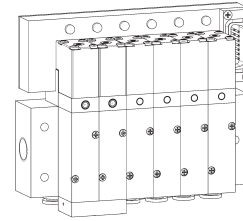
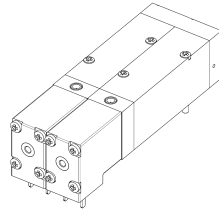

Double solenoid valves (5/2-way and 5/3-way) occupy 2 spaces.

The system is highly water resistant. D-sub-connector and individual valve positions are sealed with NBR O-rings against water and humidity offering IP 65.

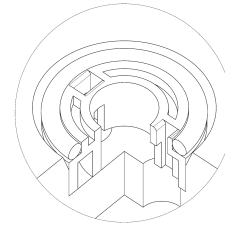
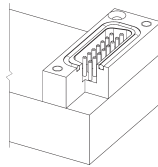

Seal at connector

Seal at valve

Position of the connector can be chosen at the right or at the left hand side of the terminal.

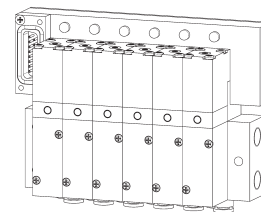
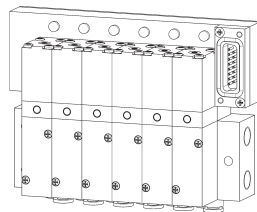

Connector right = TR16

Connector left = TL16

Cable can be supplied with an elbow or a straight electrical connector. Standard cable length is 3 m others are available on request. For details please refer to page 2.7.4.

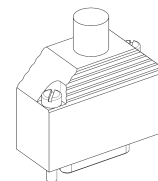
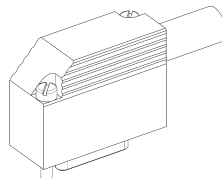

ST40 W\_\_

ST40 G\_\_

### General order information:

When ordering a Hafner valve terminal please proceed as follows:

The electrical and pneumatical manifold has the type-number:

For ordering the required valves add a T to the order code, e.g. MD 510 404 T.

The cable with the connector as displayed on page 2.7.4.

All items to be ordered separately but assembled by manufacturer.

T \_ \_ \_ \_ \_  
1 2 3 4 5 6 7 8

**1**  
R or L: Defining the side of the connector  
R = right, L = left

**2**  
16 for valves 16 mm wide  
22 for valves 22 mm wide

**3**  
3 or 5: Defining if the plate is for 3- or 5-way valves

**4, 5**  
number of positions, 02 to 14

**6, 7, 8**  
defining size and position of the ports, please refer to page 2.7.2.1 to 2.7.3.7

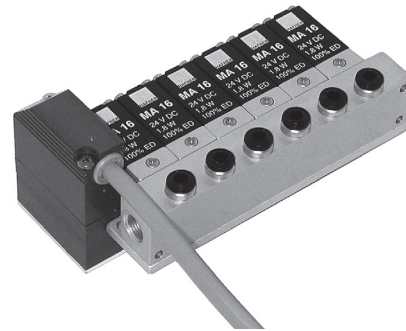
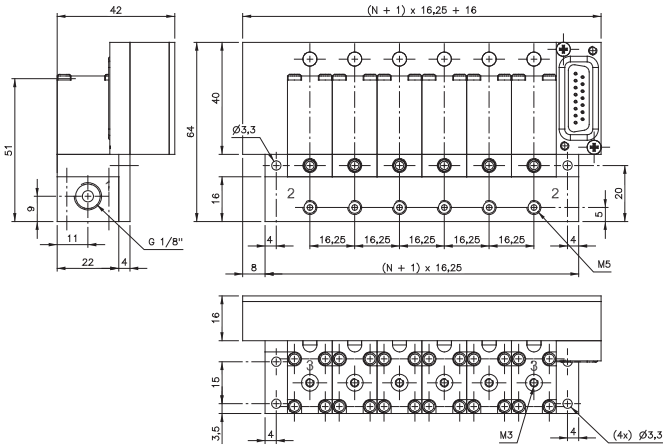

Valve terminal with direct actuated 3-way valves, orifice size 1 mm, port 2 is in the plate. Port 2 is either equipped with push-in fitting for 4 mm tube or thread M5.

T\_163\_\_104

The terminal is available from 2 to 14 stations (4 to 12 preferred stock item). Every station is equipped with a varistor and a red LED for coils 24 V= or 24 V~.

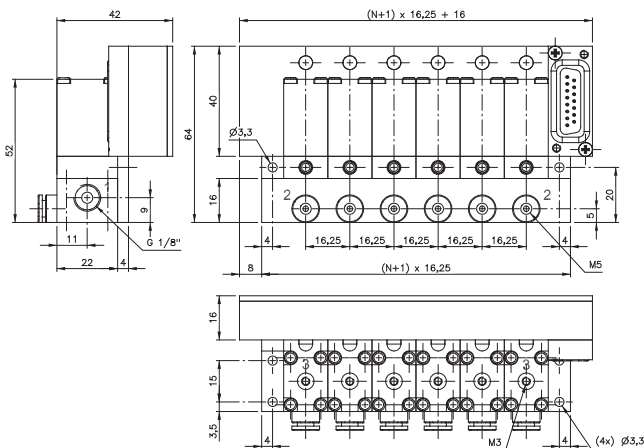

The pneumatic system (valve and manifold) is displayed and described on page 2.5.1.2.1, type RD 3\_\_104 or RD 3\_\_144.

Valves for terminal use offer a solenoid turned by 180° and no 3rd pin (ground). For ordering add a T to the regular type-number (e.g. MD 311 104 T 24DC or MD 311 104 T 24AC).

Blanking plates are also available type BP 3 104 T.

T\_163\_\_144

# T\_ 16 3 \_\_ 303

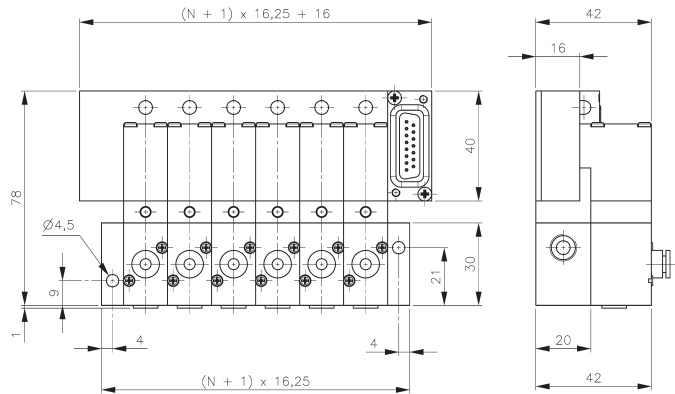
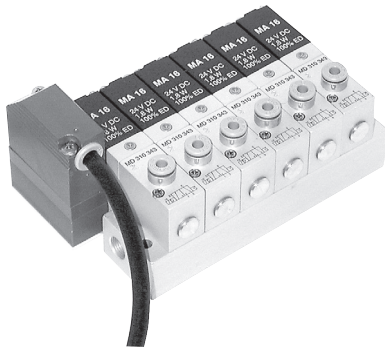

**T\_ 16 3 \_\_ 303**  
**equipped with valves type 343 T**

Valve terminal with 3-way valves, orifice size 3 mm, port 2 is in the valve. Port 2 is equipped with push-in fitting for 4 mm tube.

The terminal is available from 2 to 14 stations (4 to 12 preferred stock item). Every station is equipped with a varistor and a red LED for coils 24 V= or 24 V~.

The pneumatic manifold is displayed and described on page 2.6.1.2, type RD 3 \_\_ 303.

Valves for terminal use offer a solenoid turned by 180° and no 3rd pin (ground). For ordering please add a T to the regular type-number (e.g. MD 310 343 T 24DC or MD 310 343 T 24AC).

Blanking plates are also available type BP 3 303 T.

The following valves can be used on that type of valve-terminal:

Type	Function	Page	Comment
MD 310 343 T	n.c.	2.5.1.2.4	both types can be mixed on the plate
MOD 310 343 T	n.o.	2.5.1.2.4	both types can be mixed on the plate

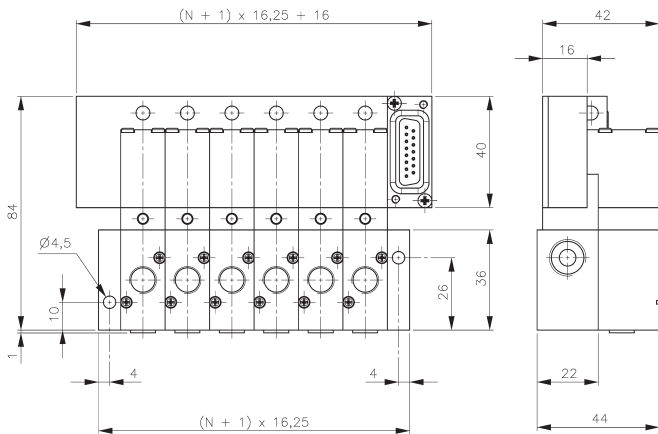

**T\_163\_\_403**  
equipped with valves type 403 T

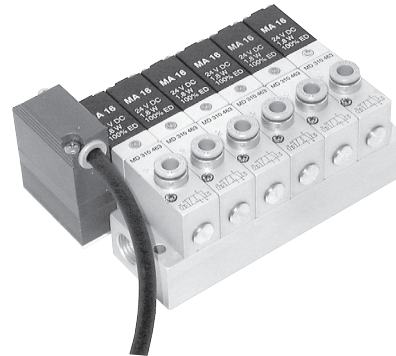

Valve terminal with 3-way valves, orifice size 4 mm, port 2 is in the valve. Port 2 is either equipped with thread G 1/8" or with push-in fitting for 6 mm tube.

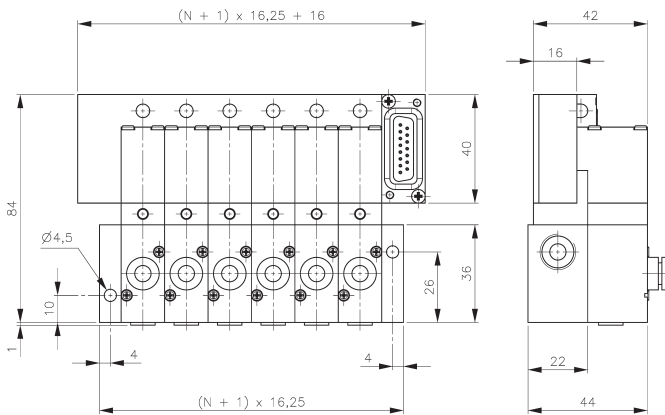

**T\_163\_\_403**  
equipped with valves type 463 T

The terminal is available from 2 to 14 stations (4 to 12 preferred stock item). Every station is equipped with a varistor and a red LED for coils 24 V= or 24 V~.

The pneumatic manifold is displayed and described on page 2.6.1.2, type RD 3\_\_ 403.

Valves for terminal use offer a solenoid turned by 180° and no 3rd pin (ground). For ordering please add a T to the regular type-number (e.g. MD 310 463 T 24DC or MD 310 463 T 24AC).

Blanking plates are also available type BP 3 403 T.

The following valves can be used on that type of valve-terminal:

Type	Function	Page	Comment
MD 310 403 T	n.c.	2.5.1.2.4	all four types of valves can be mixed on one plate
MD 310 463 T	n.c.	2.5.1.2.4	all four types of valves can be mixed on one plate
MOD 310 403 T	n.o.	2.5.1.2.4	all four types of valves can be mixed on one plate
MOD 310 463 T	n.o.	2.5.1.2.4	all four types of valves can be mixed on one plate

For additional order information please refer to page 2.7.1.

# T\_223\_\_703

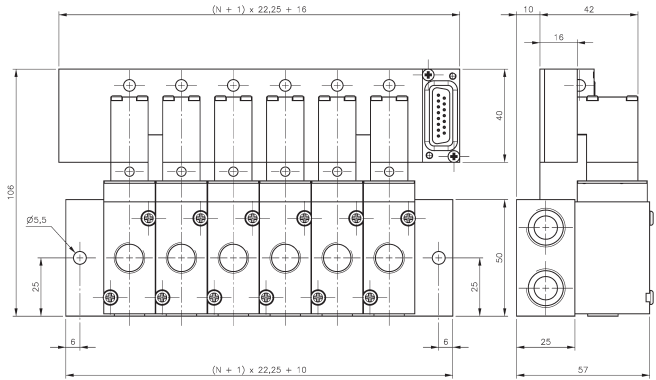
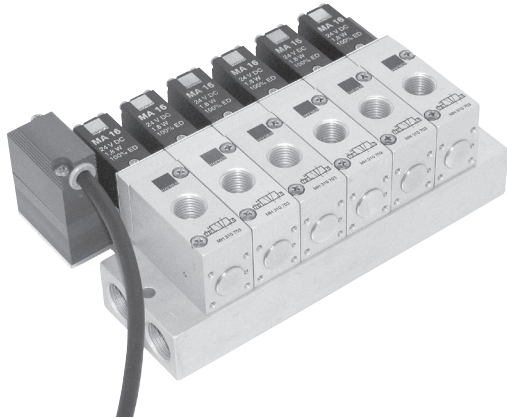

**T\_223\_\_703**  
equipped with valves type 703 T

Valve terminal with 3-way valves, orifice size 7 mm, port 2 is in the valve, G 1/4".

The terminal is available with 2, 3, 4, 5, 6, 8, 10, 12 positions, others on request. Every station is equipped with a varistor and a red LED for coils 24 V= or 24 V~.

The pneumatic manifold is displayed and described on page 2.6.1.5, type R 3 \_\_ 703.

Valves for terminal use offer a 1.8 Watt / 3 VA solenoid, turned by 180° and no 3rd pin (ground).

Order-number valves:

MK 310 703 T 24DC, MK 310 703 T 24 AC,  
MOK 310 703 T 24 DC, MOK 310 703 T 24 AC.

Blanking plates are also available type BP 3 703 T.

The following valves can be used on that type of valve terminal:

Type	Function	Page	Comment
MK 310 703 T	n.c.	2.5.1.2.6	both types can be mixed on the plate
MOK 310 703 T	n.o.	2.5.1.2.6	both types can be mixed on the plate

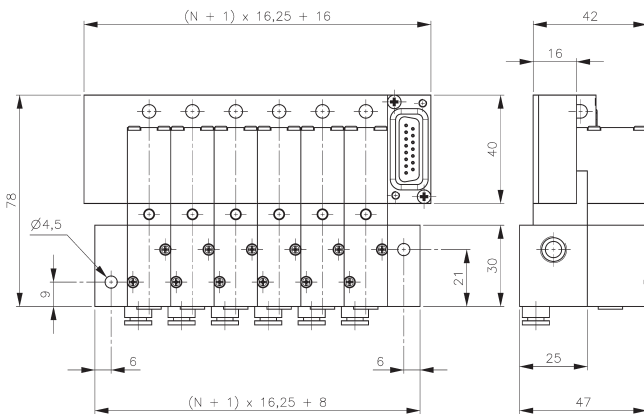

**T\_163\_\_344**  
equipped with valves type 304 T

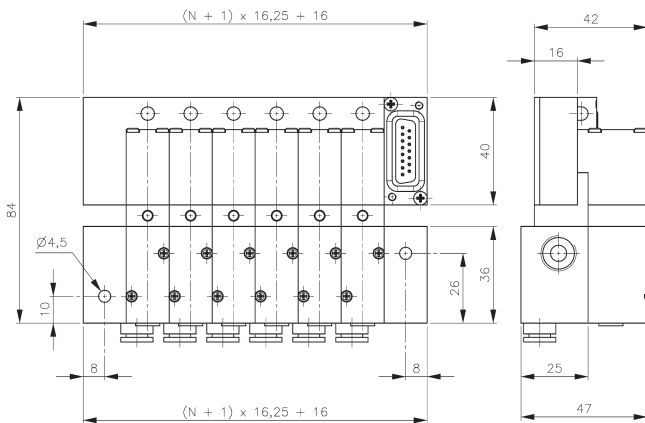

**T\_163\_\_464**  
equipped with valves type 404 T

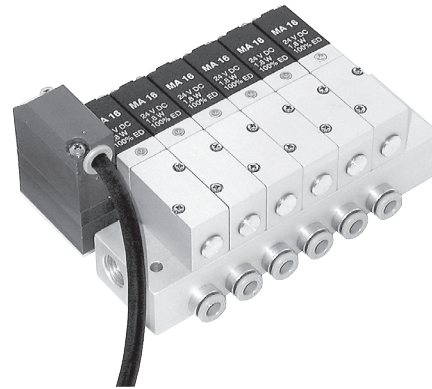

Valve terminal with 3-way valves, all ports are in the plate.

Type 344 orifice size 3 mm, port 2 is equipped with push-in fitting for 4 mm tube.

Type 464 orifice size 4 mm, port 2 is equipped with push-in fitting for 6 mm tube.

The terminal is available from 2 to 14 stations (4 to 12 preferred stock item). Every station is equipped with a varistor and a red LED for coils 24 V= or 24 V~.

The pneumatic manifolds are displayed and described on page 2.6.1.3, type RD 3\_\_344 / RD 3\_\_464.

Valves for terminal use offer a solenoid turned by 180° and no 3rd pin (ground). For ordering please add a T to the regular type-number (e.g. MD 310 304 T 24DC or MD 310 304 T 24AC).

Blanking plates are also available type BP 3 344 T or type BP 3 464 T.

The following valves can be used on T\_163\_\_344 n.c. and n.o. can be mixed.

Type	Function	Page
MD 310 304 T	n.c.	2.5.1.2.5
MOD 310 304 T	n.o.	2.5.1.2.5

The following valves can be used on T\_163\_\_464 n.c. and n.o. can be mixed.

Type	Function	Page
MD 310 404 T	n.c.	2.5.1.2.5
MOD 310 404 T	n.o.	2.5.1.2.5

For additional order information please refer to page 2.7.1.

# T\_ 16 5 \_ \_ 303

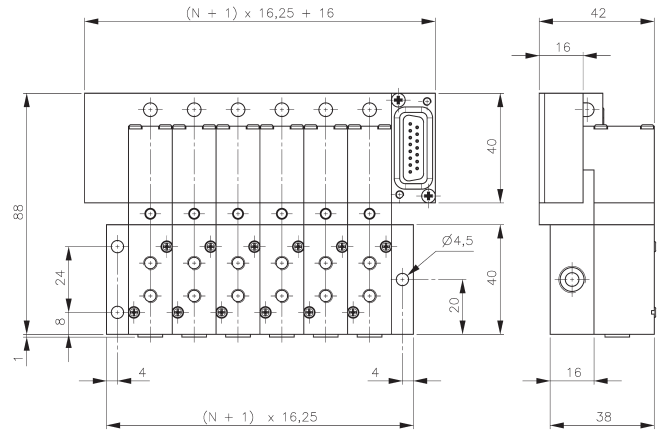
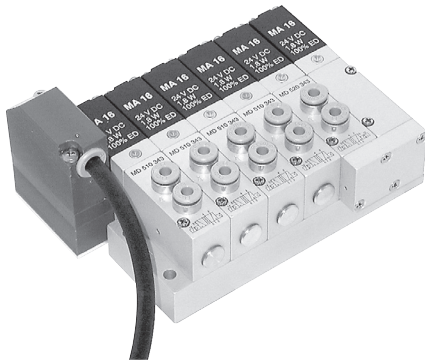

**T\_ 16 5 \_ \_ 303**  
equipped with valves type 303 T

Valve terminal with 5-way valves, orifice size 3 mm, ports 2 and 4 are in the valve. Ports 2 and 4 are either equipped with thread M5 or with push-in fittings for 4 mm tube.

The terminal is available from 2 to 14 stations (4 to 12 preferred stock item). Every station is equipped with a varistor and a red LED for coils 24 V= or 24 V~.

The pneumatic manifold is displayed and described on page 2.6.2.1, type RD 5 \_ \_ 303.

Valves for terminal use offer a solenoid turned by 180° and no 3rd pin (ground). For ordering please add a T to the regular type-number (e.g. MD 510 303 T 24DC or MD 510 303 T 24AC). "Double body valves" (5/2-way impulse and 5/3-way-valves) occupy 2 spaces as described on page 2.7.1.

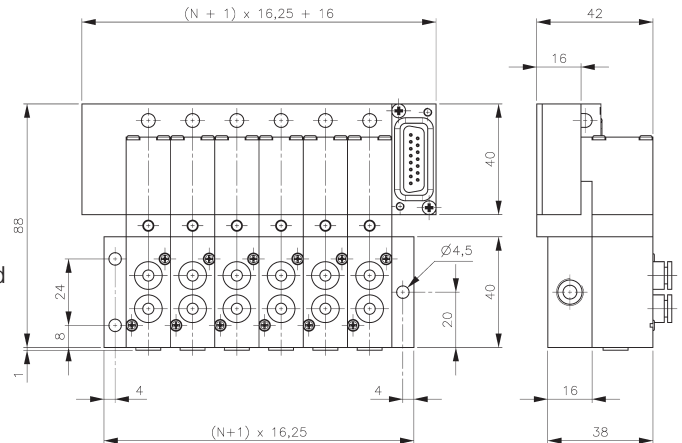

**T\_ 16 5 \_ \_ 303**  
equipped with valves type 343 T

Blanking plates are also available type BP 5 303 T.

The following valves can be used on that type of valve terminal:

Type	Function	Page	Comment
MD 510 303 T	single sol.	2.5.2.2.1	
MD 510 343 T	single sol.	2.5.2.2.1	
MD 520 303 T	double sol.	2.5.2.2.5	double body
MD 520 343 T	double sol.	2.5.2.2.5	double body
MD 53_ 303 T	5/3-way	2.5.3.2.1	double body, 3 versions available, refer to description
MD 53_ 343 T	5/3-way	2.5.3.2.1	double body, 3 versions available, refer to description

For additional order information please refer to page 2.7.1.



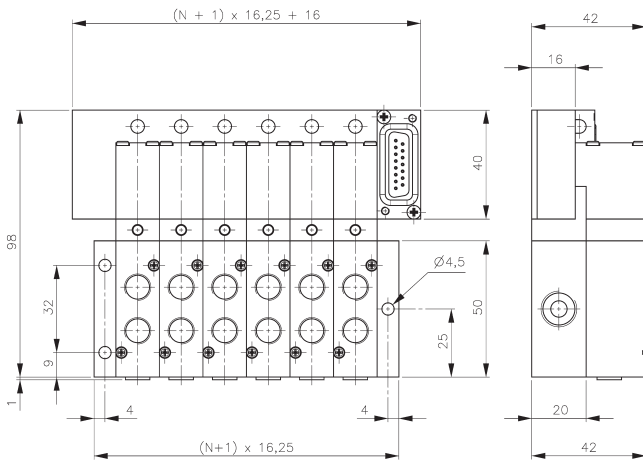

**T\_16 5\_\_403**  
equipped with valves type 403 T

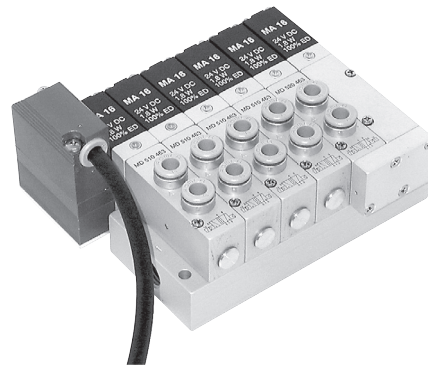

Valve terminal with 5-way valves, orifice size 4 mm, ports 2 and 4 are in the valve. Ports 2 and 4 are either equipped with thread G 1/8" or with push-in fittings for 6 mm tube.

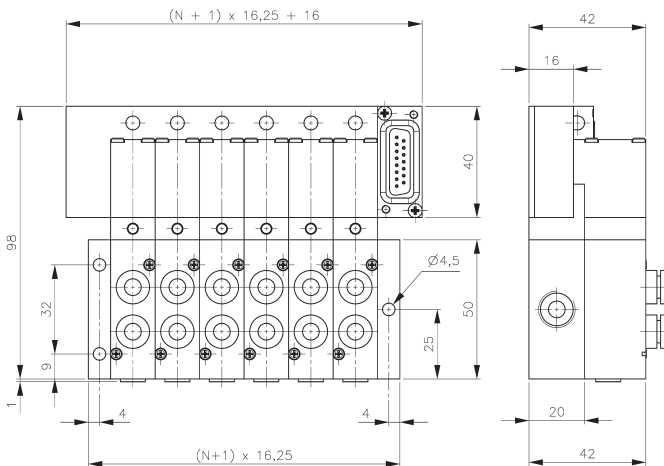

**T\_16 5\_\_403**  
equipped with valves type 463 T

The terminal is available from 2 to 14 stations (4 to 12 preferred stock item). Every station is equipped with a varistor and a red LED for coils 24 V= or 24 V~.

The pneumatic manifold is displayed and described on page 2.6.2.1, type RD 5\_\_403.

Valves for terminal use offer a solenoid turned by 180° and no 3rd pin (ground). For ordering please add a T to the regular type-number (e.g. MD 510 403 T 24DC or MD 510 403 T 24AC). "Double body valves" (5/2-way impulse and 5/3-way-valves) occupy 2 spaces as described on page 2.7.1.

Blanking plates are also available type BP 5 403 T.

The following valves can be used on that type of valve terminal:

Type	Function	Page	Comment
MD 510 403 T	single sol.	2.5.2.2.1	
MD 510 463 T	single sol.	2.5.2.2.1	
MD 520 403 T	double sol.	2.5.2.2.5	double body
MD 520 463 T	double sol.	2.5.2.2.5	double body
MD 53__403 T	5/3-way	2.5.3.2.1	double body, 3 versions available, refer to description
MD 53__463 T	5/3-way	2.5.3.2.1	double body, 3 versions available, refer to description

For additional order information please refer to page 2.7.1.

# T\_22 5\_\_ 503/T\_22 5\_\_ 703

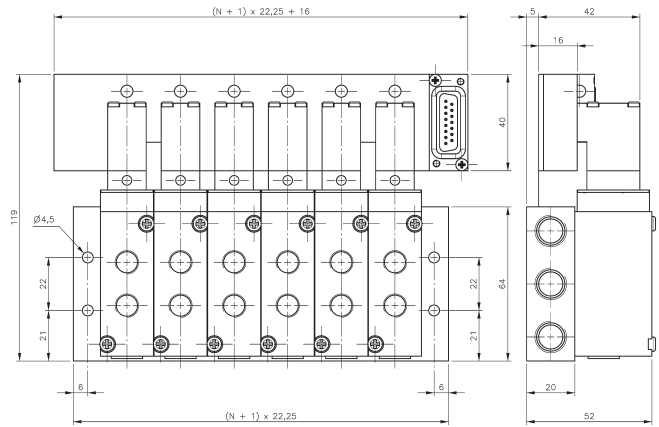

**T\_22 5\_\_ 503**  
equipped with valves type 503 T

Valve terminal with 5-way valves, ports 2 and 4 are in the valve.

Type 503 orifice size 5 mm, G 1/8"

Type 703 orifice size 7 mm, G 1/4"

The terminal is available with 2, 3, 4, 5, 6, 8, 10, 12 positions, others on request. Every station is equipped with a varistor and a red LED for coils 24 V~ or 24 V~.

The pneumatic manifolds are displayed and described on page 2.6.2.2 type R 5\_\_ 503, on page 2.6.2.3 type R 5\_\_ 703.

Valves for terminal use offer a 1.8 Watt / 3 VA solenoid, turned by 180° and no 3rd pin (ground).  
Order-number valves:

MK 5\_\_ 03 T 24DC or MK 5\_\_ 03 T 24AC.

Blanking plates are also available type BP 5 503 T or type BP 5 703 T.

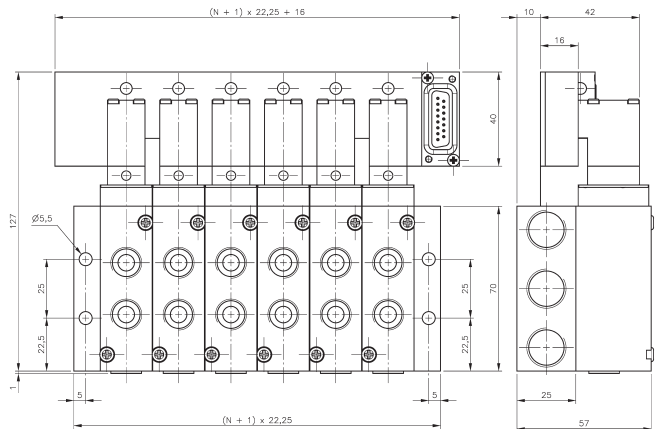

**T\_22 5\_\_ 703**  
equipped with valves type 703 T

The following valves can be used on T\_22 5\_\_ 503:

Type	Function	Page	Comment
MK 510 503 T	single sol.	2.5.2.2.2	
MK 520 503 T	double sol.	2.5.2.2.6	double body
MK53_ 503 T	5/3-way	2.5.3.2.2	double body, 3 versions available, refer to description

The following valves can be used on T\_22 5\_\_ 703:

Type	Function	Page	Comment
MK 510 703 T	single sol.	2.5.2.2.2	
MK 520 703 T	double sol.	2.5.2.2.6	double body
MK 53_ 703 T	5/3-way	2.5.3.2.2	double body, 3 versions available, refer to description

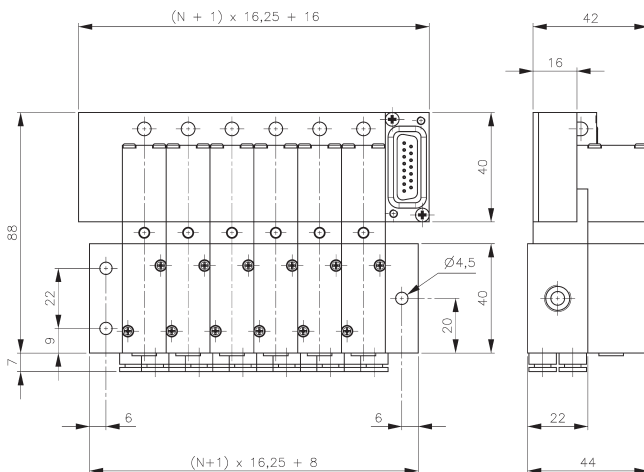

**T\_16 5\_\_344**  
equipped with valves type 304 T

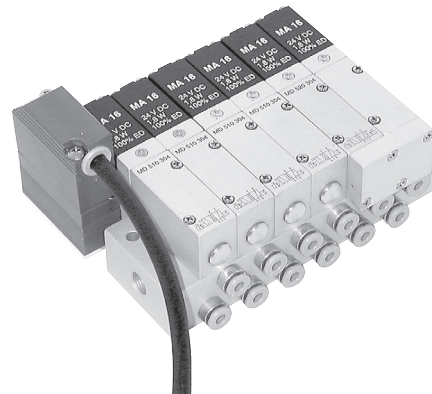

Valve terminal with 5-way valves, orifice size 3 mm, all the ports are in the plate. Ports 2 and 4 are equipped with push-in fittings for 4 mm tube.

The terminal is available from 2 to 14 stations (4 to 12 preferred stock item). Every station is equipped with a varistor and a red LED for coils 24 V= or 24 V~.

The pneumatic manifold is displayed and described on page 2.6.2.6, type RD 5\_\_344.

Valves for terminal use offer a solenoid turned by 180° and no 3rd pin (ground). For ordering please add a T to the regular type-number (e.g. MD 510 304 T 24DC or MD 510 304 T 24AC). "Double body valves" (5/2-way impulse and 5/3-way-valves) occupy 2 spaces as described on page 2.7.1.

Blanking plates are also available type BP 5 344 T.

The following valves can be used on that type of valve terminal:

Type	Function	Page	Comment
MD 510 304 T	single sol.	2.5.2.2.3	
MD 520 304 T	double sol.	2.5.2.2.7	double body
MD 53_304 T	5/3-way	2.5.3.2.3	double body, 3 versions available, refer to description

For additional order information please refer to page 2.7.1.

# T\_ 16 5\_ \_ 464

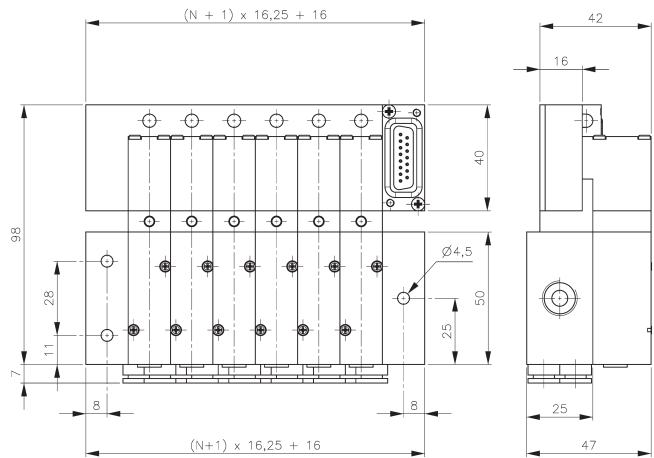
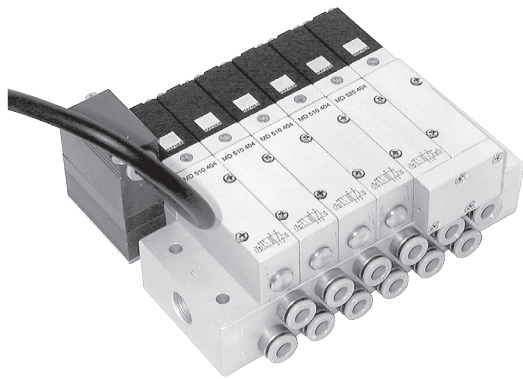

**T\_ 16 5\_ \_ 464**  
**equipped with valves type 404 T**

Valve terminal with 5-way valves, orifice size 4 mm, all the ports are in the plate. Ports 2 and 4 are equipped with push-in fittings for 6 mm tube.

The terminal is available from 2 to 14 stations (4 to 12 preferred stock item). Every station is equipped with a varistor and a red LED for coils 24 V= or 24 V~.

The pneumatic manifold is displayed and described on page 2.6.2.6, type RD 5\_ \_ 464.

Valves for terminal use offer a solenoid turned by 180° and no 3rd pin (ground). For ordering please add a T to the regular type-number (e.g. MD 510 404 T 24DC or MD 510 404 T 24AC). "Double body valves" (5/2-way impulse and 5/3-way-valves) occupy 2 spaces as described on page 2.7.1.

Blanking plates are also available type BP 5 464 T.

The following valves can be used on that type of valve terminal:

Type	Function	Page	Comment
MD 510 404 T	single sol.	2.5.2.2.3	
MD 520 404 T	double sol.	2.5.2.2.7	double body
MD 53_ 404 T	5/3-way	2.5.3.2.3	double body, 3 versions available, refer to description

For additional order information please refer to page 2.7.1.

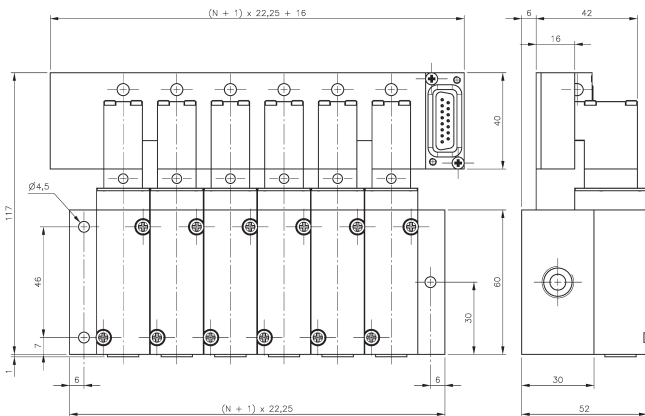

**T\_22 5\_\_ 504**  
equipped with valves type 504 T

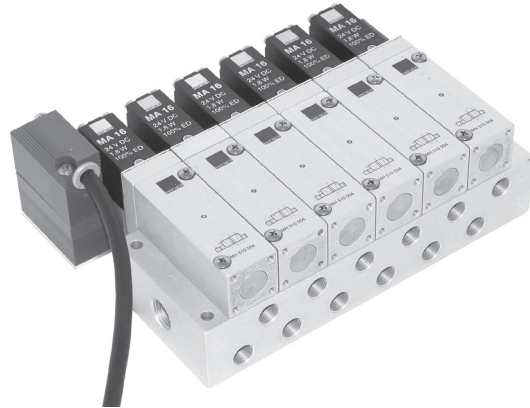

Valve terminal with 5-way valves, orifice 5 mm, all the ports are in the plate. Port 2 and 4: G 1/8".

The terminal is available with 2, 3, 4, 5, 6, 8, 10, 12 positions, others on request. Every station is equipped with a varistor and a red LED for coils 24 V= or 24 V~.

The pneumatic manifolds are displayed and described on page 2.6.2.7, type R 5\_\_ 504.

Valves for terminal use offer a 1.8 Watt / 3 VA solenoid, turned by 180° and no 3rd pin (ground).  
Order-number valves:  
MK 5\_\_ 504 T 24DC or MK 5\_\_ 504 T 24AC.

Blanking plates are also available type BP 5 504 T.

The following valves can be used on that type of valve terminal:

Type	Function	Page	Comment
MK 510 504 T	single sol.	2.5.2.2.4	
MK 520 504 T	double sol.	2.5.2.2.8	double body
MK 53_ 504 T	5/3-way	2.5.3.2.4	double body, 3 versions available, refer to description

For additional order information please refer to page 2.7.1.

# T\_22 5\_\_704/T\_22 5\_\_784

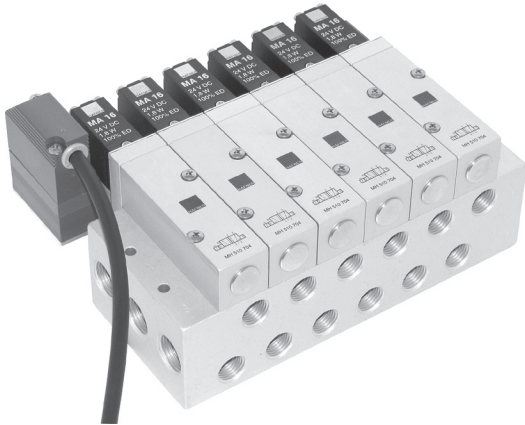

Valve terminal with 5-way valves, orifice 7 mm, all the ports are in the plate. Port 2 and 4 either G 1/4" (terminal 704) or push-in fittings for 8 mm tube (terminal 784).

The terminal is available with 2, 3, 4, 5, 6, 8, 10, 12 positions, others on request. Every station is equipped with a varistor and a red LED for coils 24 V= or 24 V~.

The pneumatic manifolds are displayed and described on page 2.6.2.7, type R 5\_\_704 / 784.

Valves for terminal use offer a 1.8 Watt / 3 VA solenoid, turned by 180° and no 3rd pin (ground).  
Order-number valves:  
MK 5\_\_704 T 24DC or MK 5\_\_704 T 24AC.

Blanking plates are also available type BP 5 704 T.

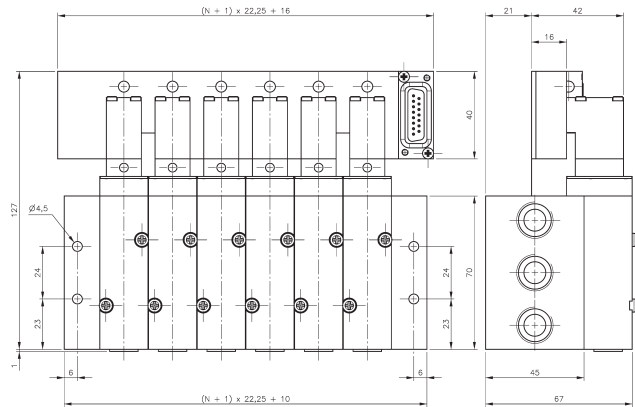

**T\_22 5\_\_704**  
equipped with valves type 704 T

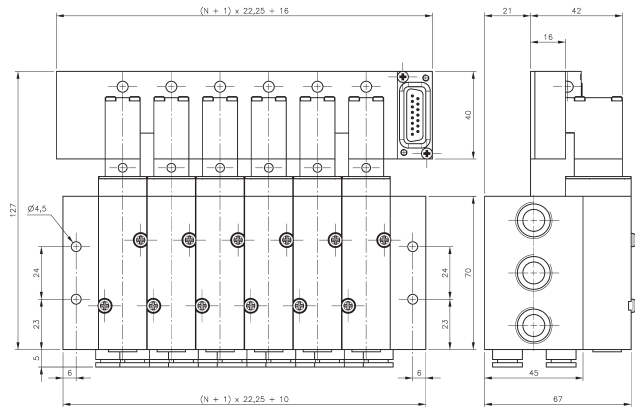

**T\_22 5\_\_784**  
equipped with valves type 704 T

The following valves can be used on that type of valve terminal:

Type	Function	Page	Comment
MK 510 704 T	single sol.	2.5.2.2.4	
MK 520 704 T	double sol.	2.5.2.2.8	double body
MK 53_704 T	5/3-way	2.5.3.2.4	double body, 3 versions available, refer to description

For additional order information please refer to page 2.7.1.

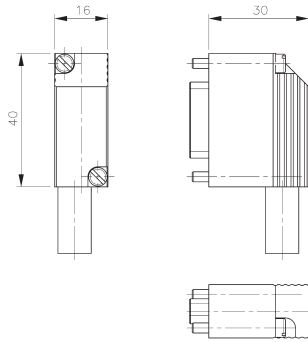

ST40 W \_\_

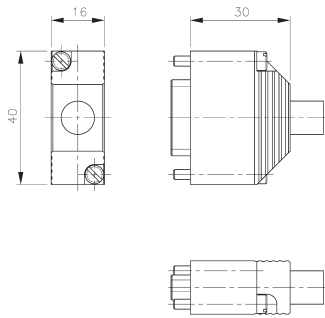

ST40 G \_\_

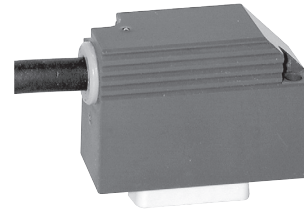

Connector and cables for Hafner valve-terminals. O-ring seal assures best protection against water and humidity. Standard cable length is 3 m, others are available on request.

2 screws are included.

**Relationship of valve-position, cable-colour and PINS in the connector**

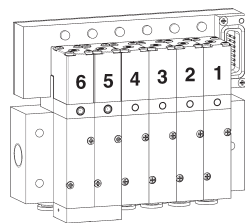
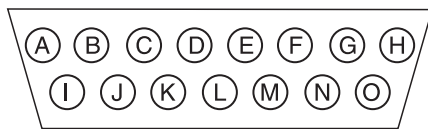

**Please be aware: Always count position of solenoid from the connector !**

Position of solenoid	Colour of cable	PIN
1	brown	K
2	green	M
3	yellow	C
4	grey	F
5	pink	J
6	blue	N
7	red	B
8	black	G
9	violet	I
10	grey-pink	O
11	blue-red	A
12	white-green	H
13	brown-green	D
14	white-yellow	E
common – or +	white	L

Type	Exit of cable	Number of laces
ST40 W6	at the side	7, 6 positions and common Plus or Minus
ST40 W14	at the side	15, 14 positions and common Plus or Minus
ST40 G06	at the back	7, 6 positions and common Plus or Minus
ST40 G14	at the back	15, 14 positions and common Plus or Minus

# Examples for customer-specific products

Hafner together with partners is currently working on an innovative system to further integrate electronic intelligence into the valve-terminal range. More information to come!

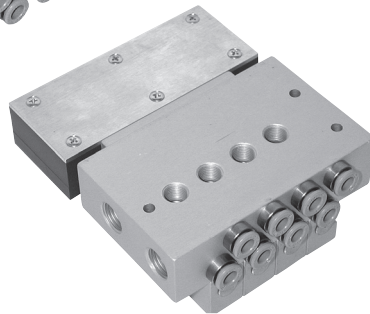
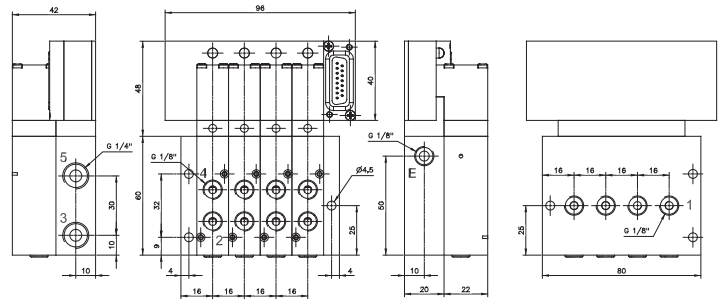
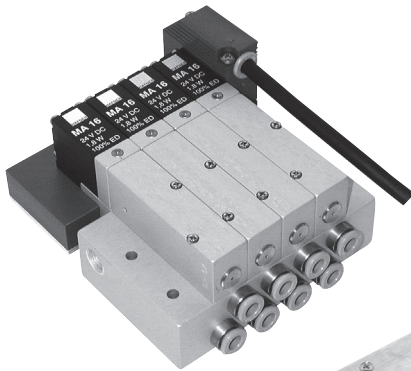
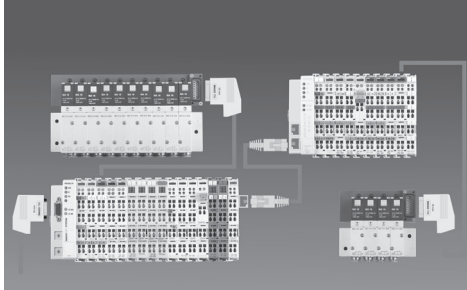
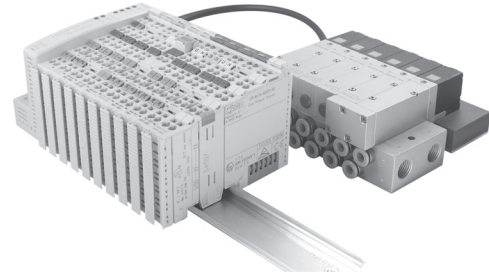

## TR 16 - E

This special terminal offers external pilot feed, therefore there is an additional port 14 in the plate. Valves are equipped with mechanic spring return. In addition this special plate offers individual ports 1 for every valve, thus the operating pressure of any valve can be different.

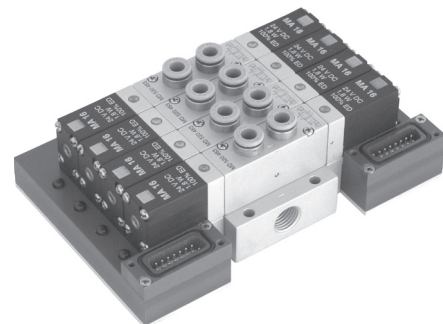

## TD 16

In case customers have the demand for only double solenoid or 5/3-way-valves on the terminal two electrical components can be assembled on either side. Therefore up to 14 valves can be put onto the terminal. Solution is only possible when port 2 and 4 is in the valve.