

# 10 mm Solenoid Valves

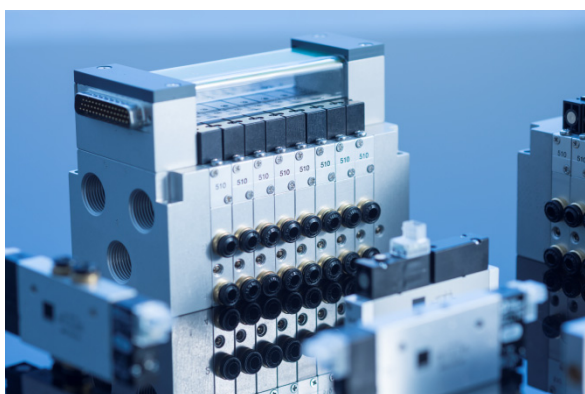

- **0.6 W Power Consumption**
- **10,5 mm wide**
- **230 l/min air-flow**
- **Service friendly design**
- **High quality solenoid system**

# Table of Contents

## page

	<b>5/2 way in-line valves</b>		
3	MMD 510 301 24DC	M5	single solenoid
3	MMD 510 341 24DC	pif 4 mm	single solenoid
4	MMD 520 301 24DC	M5	double solenoid
4	MMD 520 341 24DC	pif 4 mm	double solenoid
	<b>5/3 way in-line valves</b>		
5	MMD 53_ 301 24DC	M5	
5	MMD 53_ 341 24DC	pif 4 mm	
	<b>Double 3/2-way base-mounted valves</b>		
6	MMD 23_ 304 24DC	ports in the plate	
	<b>5/2 way base-mounted valves</b>		
7	MMD 510 304 24DC	ports in the plate	single solenoid
7	MMD 520 304 24DC	ports in the plate	double solenoid
	<b>5/3 way base-mounted valves</b>		
8	MMD 53_ 304 24DC	ports in the plate	
	<b>Modular manifold plates</b>		
9	RM 5 304 L/ RM 5 304 R/RM 5 344	end-plate left, right, individual position	
	<b>Valve Terminals</b>		
10	T_ 10 5_ _ 344	Valve Terminals	
11	ST 54_ 0 L3000	Connector	

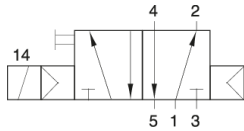

MMD 510 301 24DC  
MMD 510 341 24DC

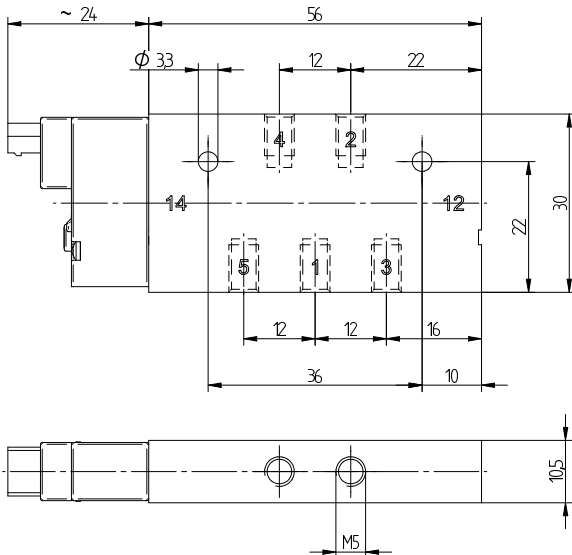

**MMD 510 301 24DC**

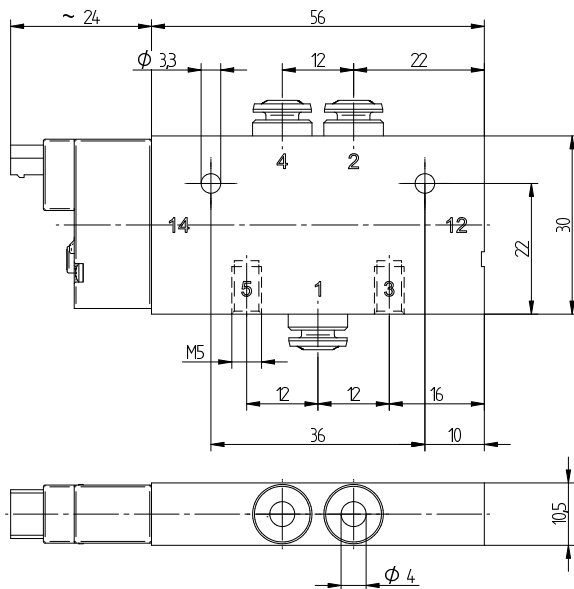

**MMD 510 341 24DC**

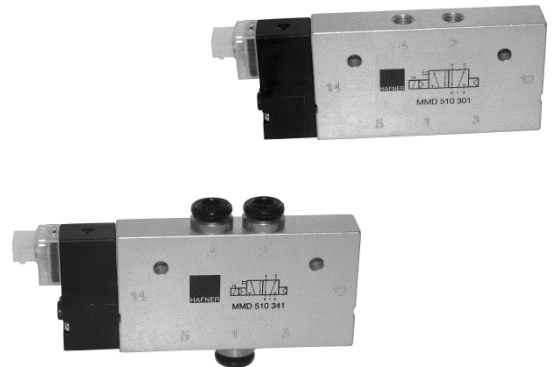

5/2-way solenoid valve actuated by permanent signal and equipped with air spring return.

Available with 24V= solenoid system for connector according to JPC standard.  
12V= available on request.

Solenoid with integrated LED and varistor.  
Protection class IP 40.

Valves are generally equipped with manual override to push.

Temperature range: -10°C to +50°C

Connector according to JPC standard with a cable length of 300 mm is included.

Type	Ports 1, 2, 4	Air flow	Operating press.	Power consumption	Weight
MMD 510 301 24DC	M5	230 l/min	3 – 8 bar	0,6 W	0,058 kg
MMD 510 341 24DC	pif 4 mm	230 l/min	3 – 8 bar	0,6 W	0,064 kg

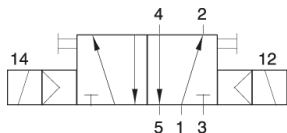

MMD 520 301 24DC  
MMD 520 341 24DC

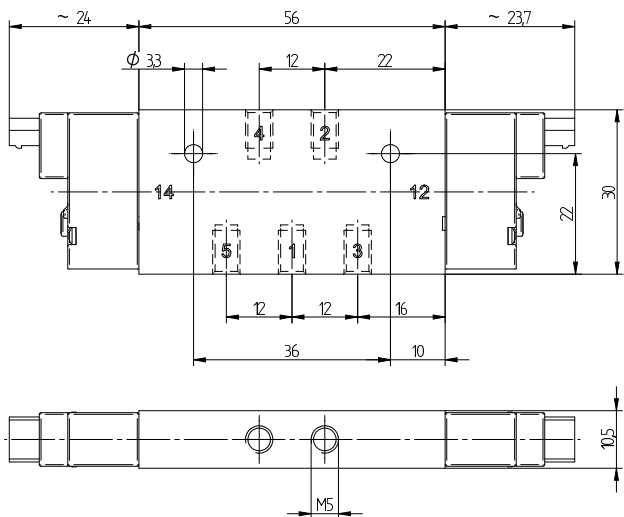

**MMD 520 301 24DC**

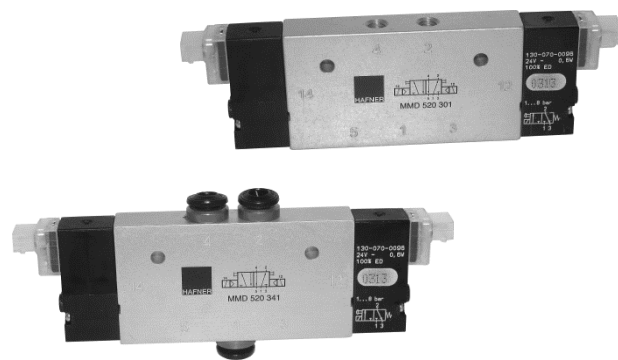

5/2-way double solenoid valve actuated by impulse. Position is kept until an electrical signal is applied to the opposite side even when not attached to electrical signal.

Available with 24V= solenoid system for connector according to JPC standard. 12V= available on request.

Solenoid with integrated LED and varistor. Protection class IP 40.

Valves are generally equipped with manual override to push.

Temperature range: -10°C to +50°C

Connectors according to JPC standard with a cable length of 300 mm are included.

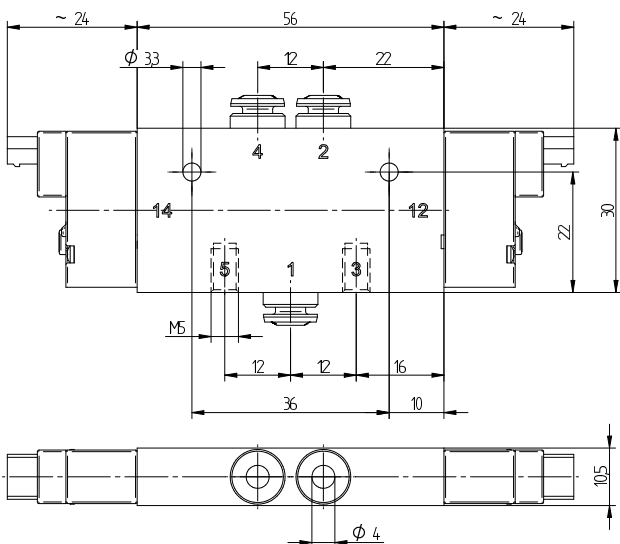

**MMD 520 341 24DC**

Type	Ports 1,2, 4	Air flow	Operating press.	Power consumption	Weight
MMD 520 301 24DC	M5	230 l/min	3 – 8 bar	0,6 W	0,068 kg
MMD 520 341 24DC	pif 4 mm	230 l/min	3 – 8 bar	0,6 W	0,074 kg

MMD 531 301 24DC  
MMD 531 341 24DC

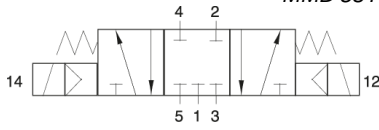

MMD 532 301 24DC  
MMD 532 341 24DC

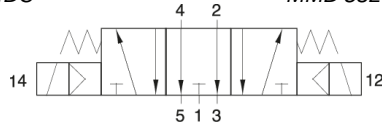

MMD 533 301 24DC  
MMD 533 341 24DC

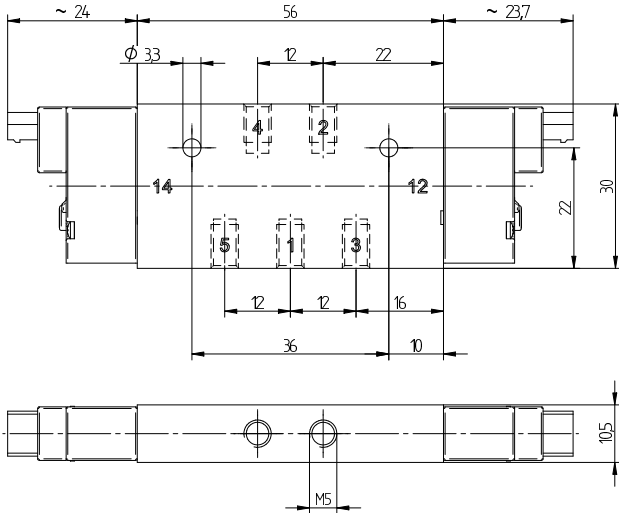
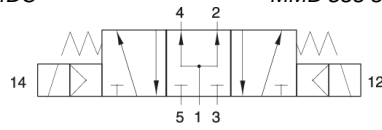

**MMD 53\_ 301 24DC**

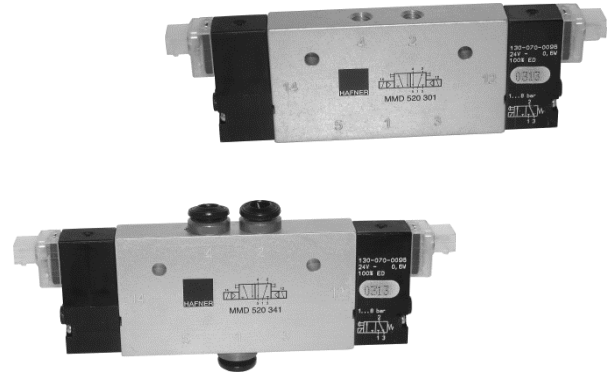

5/3-way solenoid valve with spring return to middle position, actuated by permanent signal.

- Type 531      centre closed
- Type 532      centre exhausted
- Type 533      centre pressurised

*When ordering please complete the type number by 1, 2 or 3 according to the type required.*

Available with 24V= solenoid system for connector according to JPC standard.  
12V= available on request.

Solenoid with integrated LED and varistor.  
Protection class IP 40.

Valves are generally equipped with manual override to push.

Temperature range: -10°C to +50°C

Connectors according to JPC standard with a cable length of 300 mm are included.

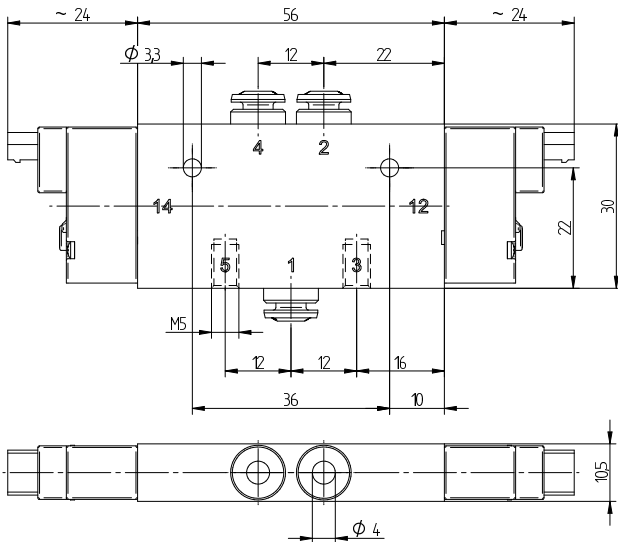

**MMD 53\_ 341 24DC**

Type	Ports 1,2, 4	Air flow	Operating press.	Power consumption	Weight
MMD 53_ 301 24DC	M5	230 l/min	3 – 8 bar	0,6 W	0,068 kg
MMD 53_ 341 24DC	pif 4 mm	230 l/min	3 – 8 bar	0,6 W	0,074 kg

MMD 231 304 24DC

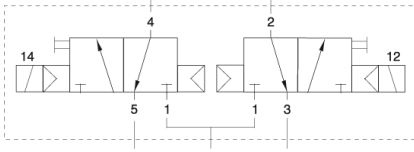

MMD 232 304 24DC

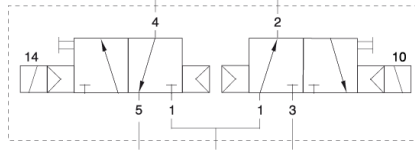

MMD 233 304 24DC

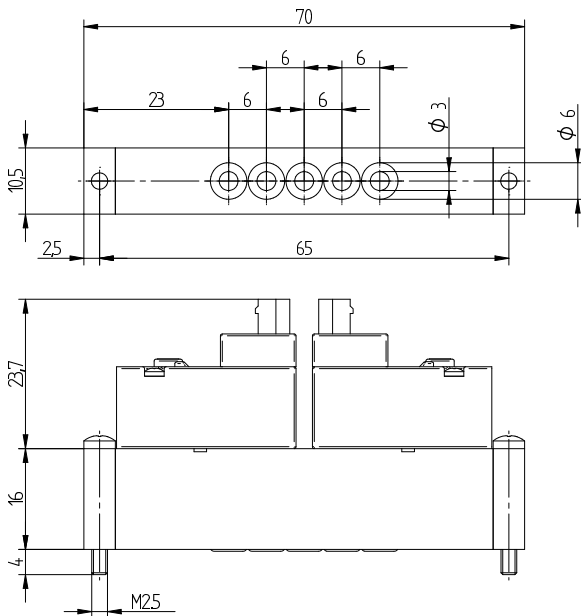
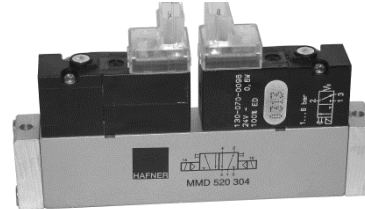
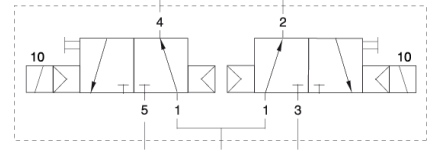

**MMD 23\_ 304 24DC**

Double 3/2-way solenoid valve actuated by permanent signal and equipped with air spring return.

- Type 231      NC & NC
- Type 232      NC & NO
- Type 233      NO & NO

When ordering please complete the type number by 1, 2 or 3 according to the type required.

Available with 24V= solenoid system for connector according to JPC standard.  
12V= available on request.

Solenoid with integrated LED and varistor.  
Protection class IP 40.

Valves are generally equipped with manual override to push.

Temperature range: -10°C to +50°C

Connectors according to JPC standard with a cable length of 300 mm are included.

Modular manifold system type RM 5 304 on page 9, valve terminals on page 10.

Type	Port size	Air flow	Operating press.	Power consumption	Weight
MMD 23_ 304 24DC	∅ 3 mm	230 l/min	3 – 8 bar	0,6 W	0,054 kg

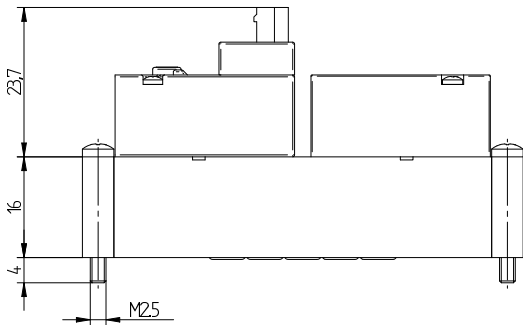
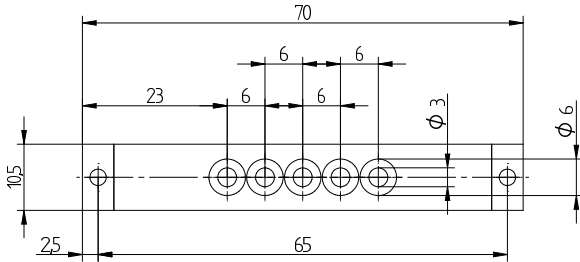
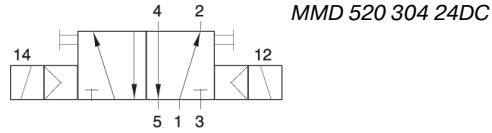
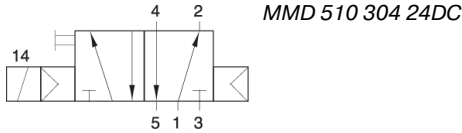

**MMD 510 304 24DC**

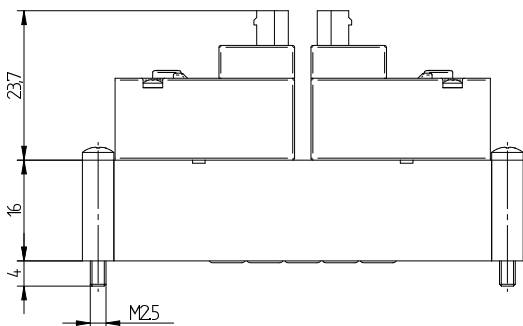
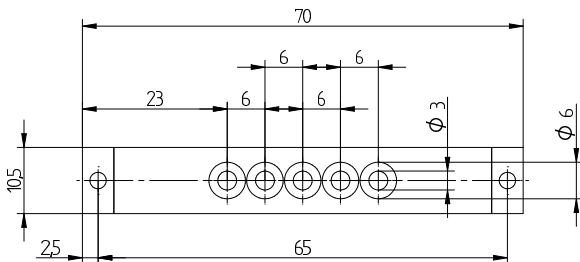

**MMD 520 304 24DC**

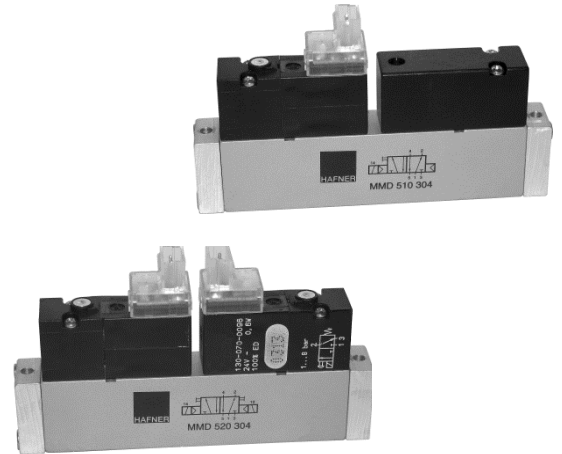

**MMD 510 304:**

5/2-way solenoid valve actuated by permanent signal and equipped with air spring return. All the ports are in the plate.

**MMD 520 304:**

5/2-way double solenoid valve actuated by impulse. Position is kept until an electrical signal is applied to the opposite side even when not attached to electrical signal. All the ports are in the plate.

Available with 24V= solenoid system for connector according to JPC standard. 12V= available on request.

Solenoid with integrated LED and varistor. Protection class IP 40.

Valves are generally equipped with manual override to push.

Temperature range: -10°C to +50°C

Connector according to JPC standard with a cable length of 300 mm is included. MMD 520 304 24DC equipped with two connectors.

Modular manifold system type RM 5 304 on page 9, valve terminals on page 10.

Type	Port size	Air flow	Operating press.	Power consumption	Weight
MMD 510 304 24DC	∅ 3 mm	230 l/min	3 – 8 bar	0,6 W	0,054 kg
MMD 520 304 24DC	∅ 3 mm	230 l/min	3 – 8 bar	0,6 W	0,054 kg

MMD 531 304 24DC

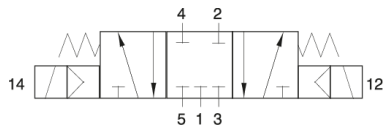

MMD 532 301 24DC

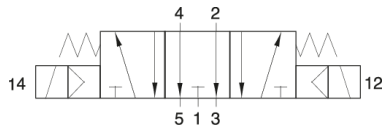

MMD 533 301 24DC

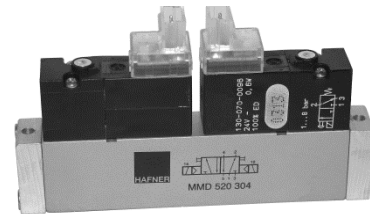
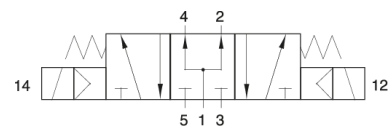

5/3-way solenoid valve with spring return to middle position, actuated by permanent signal. All the ports are in the plate.

- Type 531        centre closed
- Type 532        centre exhausted
- Type 533        centre pressurised

*When ordering please complete the type number by 1, 2 or 3 according to the type required.*

Available with 24V= solenoid system for connector according to JPC standard. 12V= available on request.

Solenoid with integrated LED and varistor. Protection class IP 40.

Valves are generally equipped with manual override to push.

Temperature range: -10°C to +50°C

Connectors according to JPC standard with a cable length of 300 mm are included.

Modular manifold system type RM 5 304 on page 9, valve terminals on page 10.

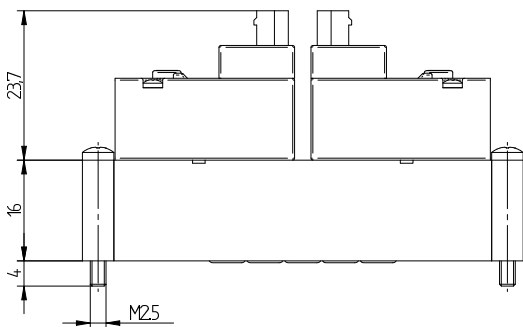
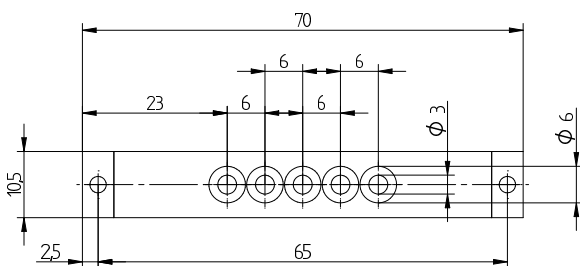

**MMD 53\_ 304 24DC**

Type	Port size	Air flow	Operating press.	Power consumption	Weight
MMD 53_ 304 24DC	Ø 3 mm	230 l/min	3 – 8 bar	0,6 W	0,054 kg



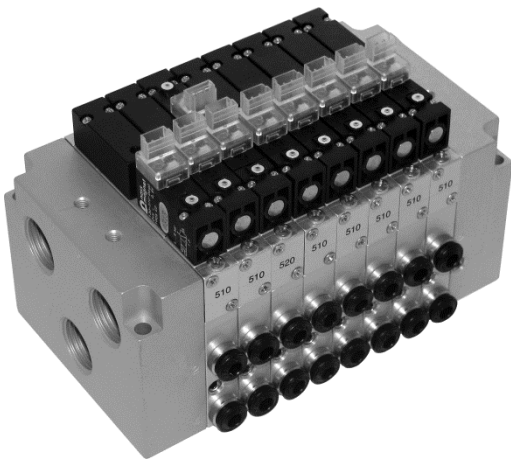

Modular manifold system for common connection to ports 1 (pressure), 3 and 5 (exhaust). Ports 2 and 4 of the individual valves are also located in the manifold plate and equipped with 4 mm push-in fittings.

The system can be build and taken apart just by operating two hexagon socket screws. Additional stations can be added at any position and any time.

Valves to be screwed from the top onto the modular manifold plate.

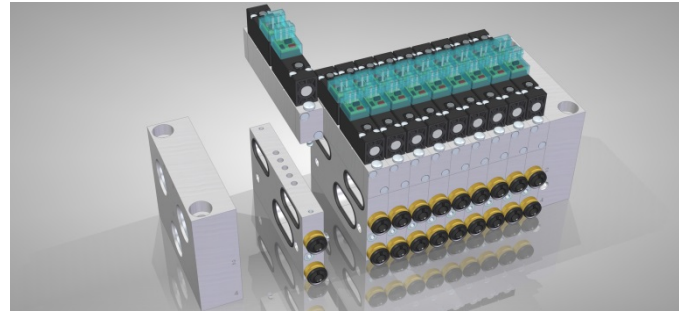

The following valves can be assembled to the manifold plate RM 5\_\_ 304:

Type	Function	Page
MMD 231 304 24DC	Double 3/2-way (NC&NC)	6
MMD 232 304 24DC	Double 3/2-way (NC&NO)	6
MMD 233 304 24DC	Double 3/2-way (NO&NO)	6
MMD 510 304 24DC	5/2 single sol.	7
MMD 520 304 24DC	5/2 double sol.	7
MMD 531 304 24DC	5/3 solenoid, closed	8
MMD 532 304 24DC	5/3 solenoid, exhausted	8
MMD 533 304 24DC	5/3 solenoid, pressurized	8

Blanking plates are also available type BPM 5 304.

The plates can also be ordered assembled by the manufacturer. In this case order RM 5\_\_ 344. Please add two digits for the number of positions required.

End-plates do not offer a valve-position.

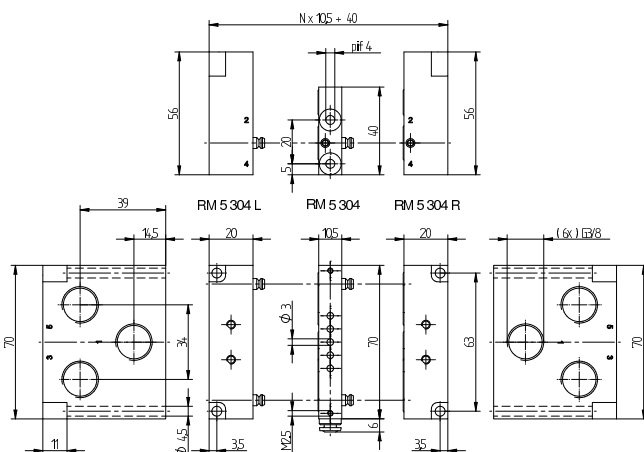

**RM 5 304 L/RM 5 344/RM 5 304 R**

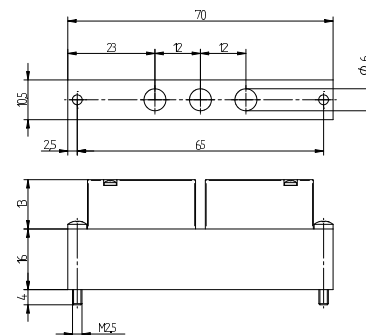

**BPM 5 304**

Type	Function	Ports	Weight
RM 5 304 L	End-plate left	G 3/8"	0,176 kg
RM 5 304 R	End-plate right	G 3/8"	0,176 kg
RM 5 344	Individual position	pif 4 mm	0,064 kg
BPM 5 304	Blanking plate	-	0,054 kg

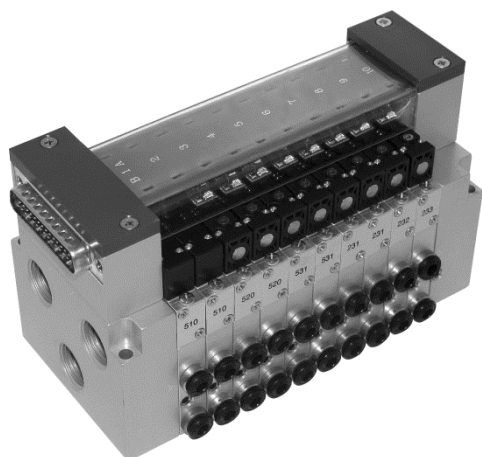

Valve terminal with 2 to 20 valve positions for valves with one or two solenoids. Common connection to ports 1 (pressure), 3 and 5 (exhaust). Ports 2 and 4 of the individual valves are also located in the manifold plate and equipped with 4 mm push-in fittings.

Valves are screwed from the top onto the modular manifold plate. Electric part is added afterwards. The electric part has a defined number of positions and can be chosen with cable connection either on the left or on the right side. The following illustration shows a TR 10 510 344.

The TL 10 has the connector on the opposite side.

The following valves can be assembled to the valve terminal T\_10 5 \_\_ 344:

Type	Function	Page
MMD 231 304 24DC T	Double 3/2-way (NC&NC)	6
MMD 232 304 24DC T	Double 3/2-way (NC&NO)	6
MMD 233 304 24DC T	Double 3/2-way (NO&NO)	6
MMD 510 304 24DC T	5/2 single sol.	7
MMD 520 304 24DC T	5/2 double sol.	7
MMD 531 304 24DC T	5/3 solenoid, closed	8
MMD 532 304 24DC T	5/3 solenoid, exhausted	8
MMD 533 304 24DC T	5/3 solenoid, pressurized	8

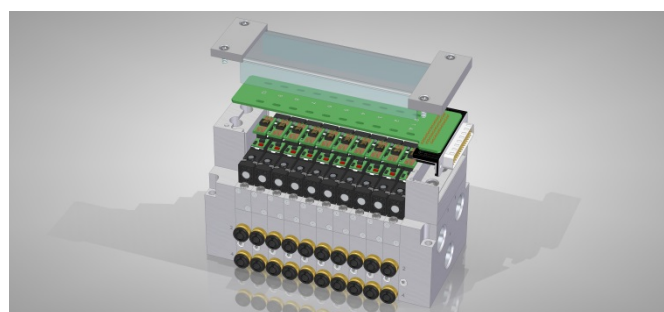

Blanking plates are also available type BPM 5 304, displayed on page 9.

The valve terminal will be equipped and tested by the manufacturer. Please advise configuration.

End-plates do not offer a valve-position.

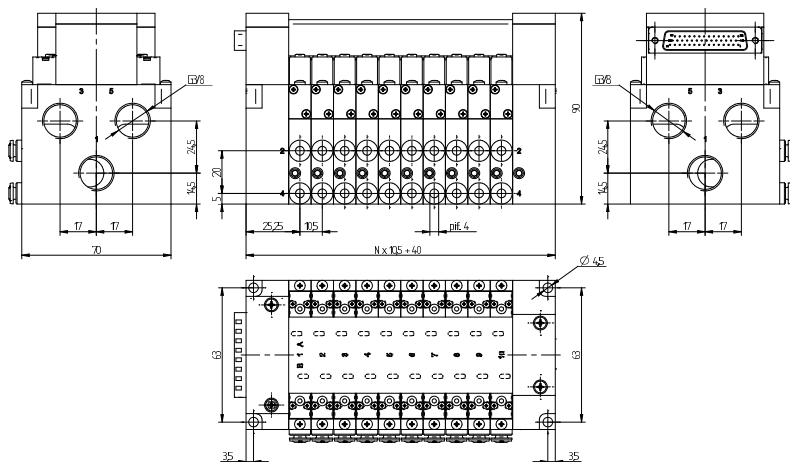

T\_10 5 \_\_ 344

Type	Connector	Comment
TR 10 5 __ 344	On the right side	Please amend the type number by the required positions
TL 10 5 __ 344	On the left side	Please amend the type number by the required positions

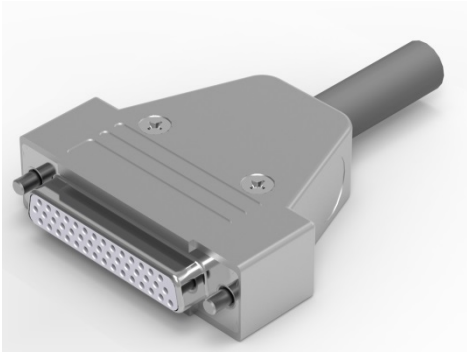

Straight electrical connector for 10 mm valve terminals.  
Cable can be offset by 2 x 90°.  
Standard cable length 3000 mm, others on request.

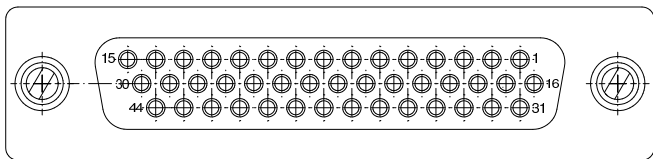
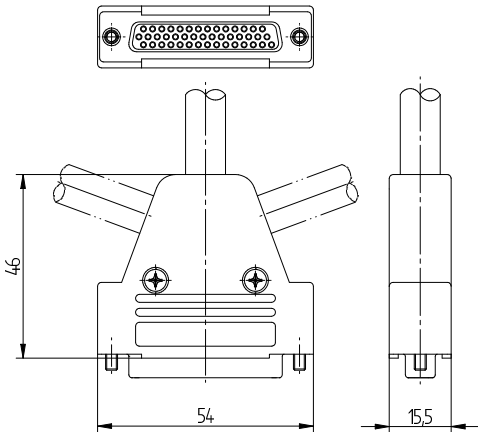

### PIN-numbering

Valve	Solenoid	Colour	PIN
1	A	brown	23
	B	yellow	37
2	A	green	38
	B	red	22
3	A	blue	9
	B	pink	7
4	A	grey	24
	B	violet	36
5	A	black	39
	B	brown-green	21
6	A	white-green	10
	B	red-blue	6
7	A	grew-pink	25
	B	yellow-brown	35
8	A	white-yellow	40
	B	pink-brown	20
9	A	white-pink	11
	B	grey-brown	5
10	A	white-grey	26
	B	white-red	34
11	A	white-blue	41
	B	grey-green	19
12	A	brown-black	12
	B	white-black	4
13	A	brown-red	27
	B	pink-green	33
14	A	yellow-grey	42
	B	green-red	18
15	A	yellow-blue	13
	B	green-blue	3
16	A	yellow-pink	28
	B	grey-blue	32
17	A	yellow-black	29
	B	green-black	17
18	A	yellow-red	43
	B	grey-red	2
19	A	pink-blue	14
	B	grey-black	31
20	A	pink-red	44
	B	blue-black	16
common +/- up to 10 valves		white	8
2. common +/- for 11 to 20 valves		brown-blue	8
Without function		pink-black	
		red-black	

Solenoid A and B are marked on the terminal.  
For TR10 solenoids A are on valve-side 12, the B solenoids are on valve-side 14.  
For TL10 solenoids A re on valve-side 14, the B solenoids are on valve-side 12.

Type	Comment
ST 54 20 L3000	Connector for up to 10 valves
ST 54 40 L3000	Connector for up to 20 valves



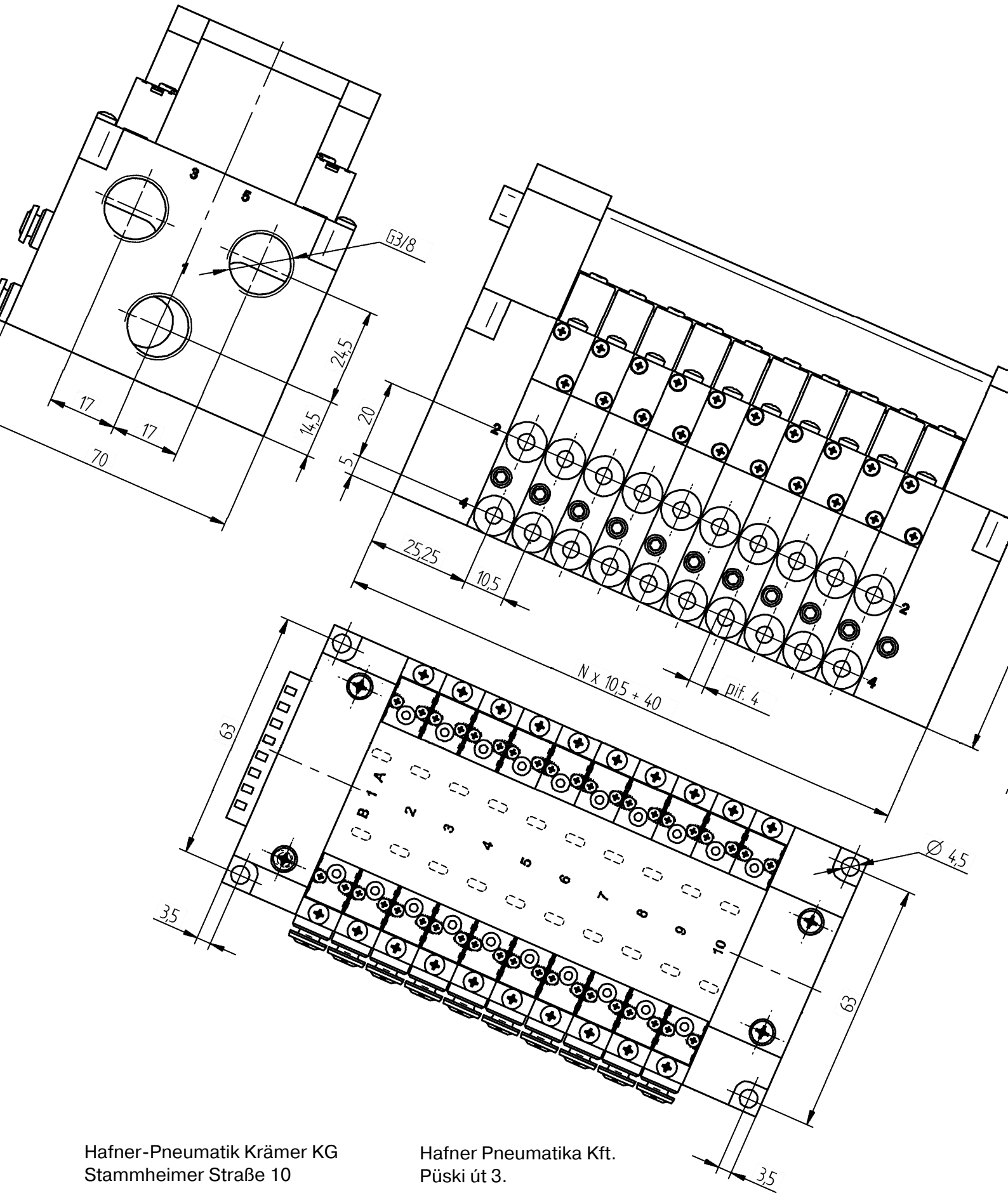

Hafner-Pneumatik Krämer KG  
Stammheimer Straße 10

D-70806 Kornwestheim

Phone +49 - 7154 - 17 85 890  
Fax +49 - 7154 - 17 85 89 28

info@hafner-pneumatik.de  
www.hafner-pneumatik.de

Hafner Pneumatika Kft.  
Püski út 3.

H-9228 Halászi

Phone +36 - 96 - 57 30 12  
Fax +36 - 96 - 21 06 15

ertekesites@hafner-pneumatika.com  
www.hafner-pneumatika.com

